

As-18

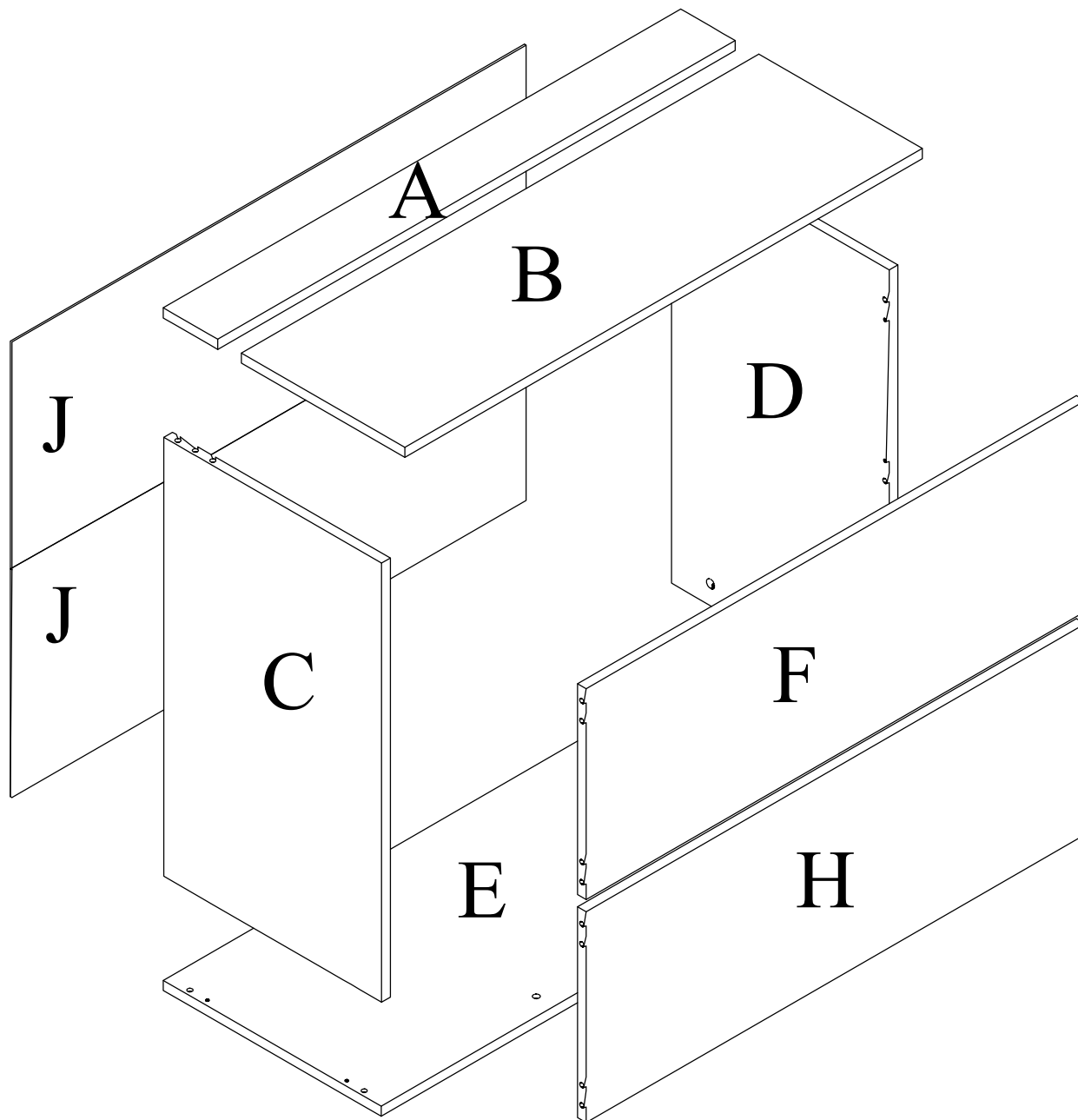

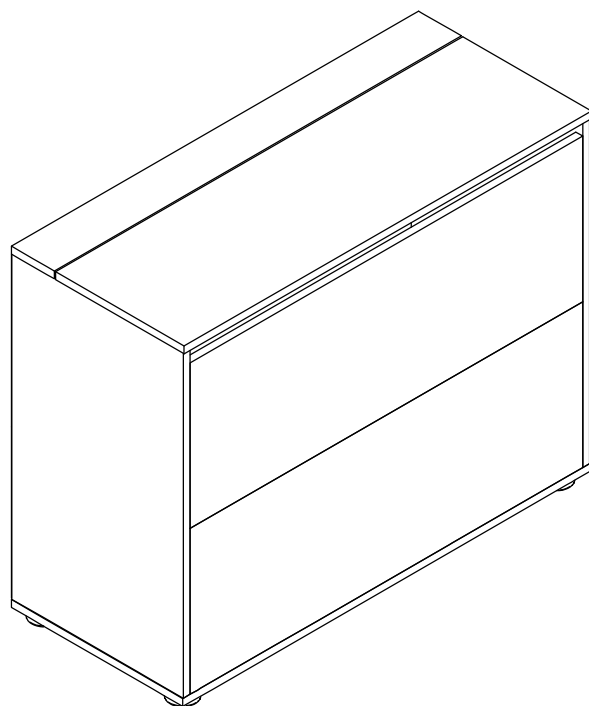
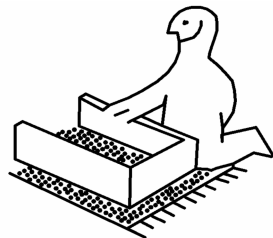
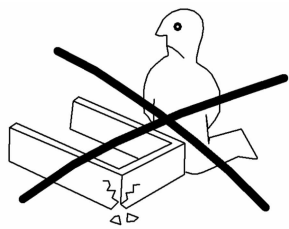
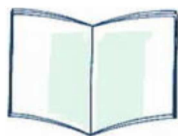
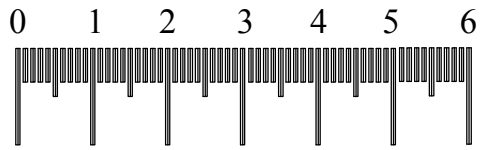

1x		0013K		1x	0018K		14x										
0001K		16x	0079K		2x	0004V		2x	0061K		4x	0016K		30x	0012V		20x
8x40				4x30										3x20			

1.)

0001K	16x
8x40	

2.)

0079K	2x

3.)

0061K	4x

4.)

0019K	14x

5.)

0018K 12x

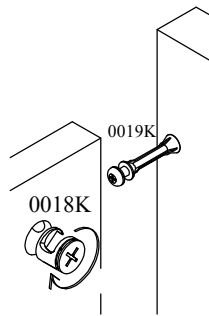
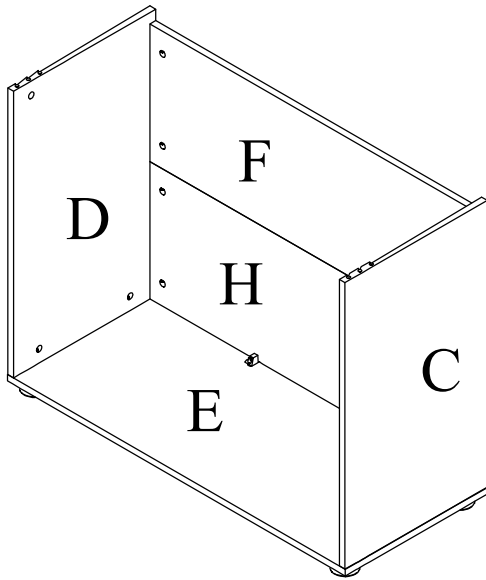
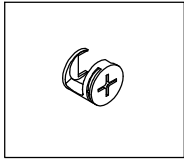

7.)

0004V 2x  
4x30

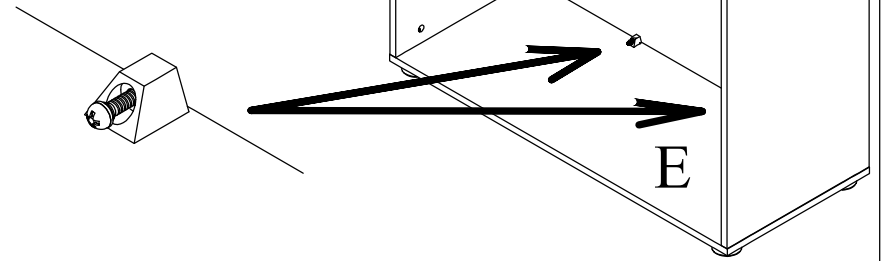
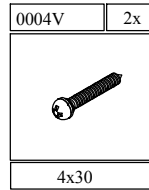

6.)

0018K 2x

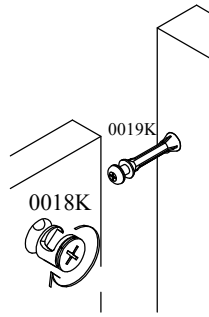
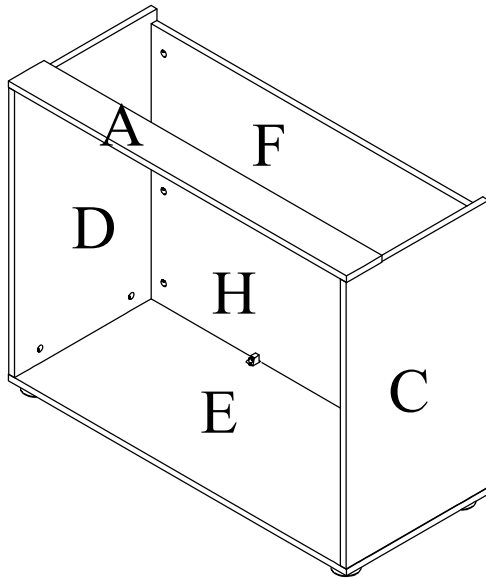
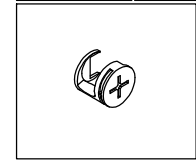

8.)

0016K 30x

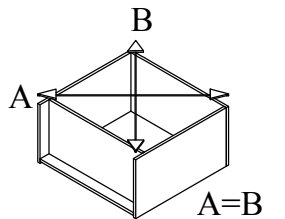
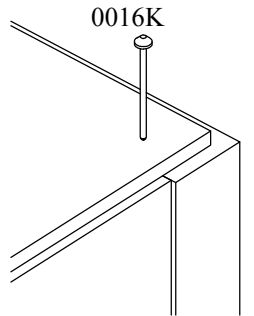
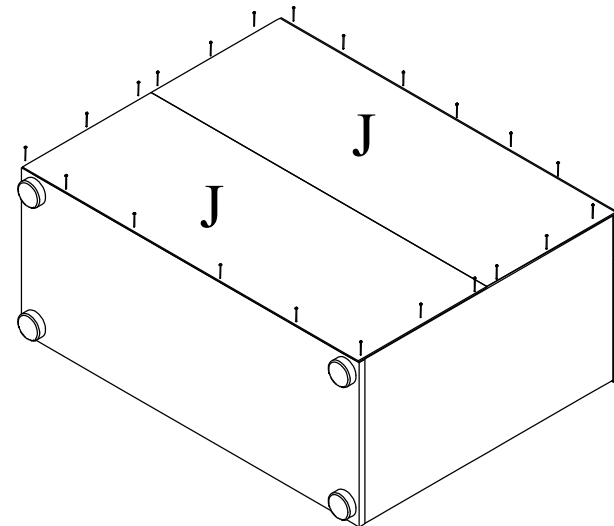
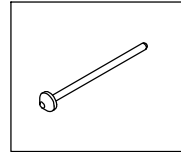

9.)

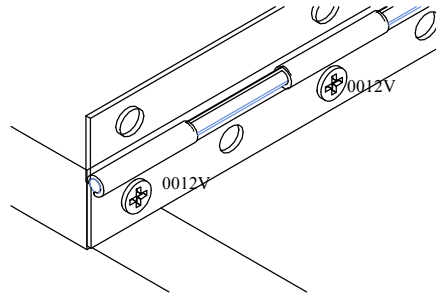
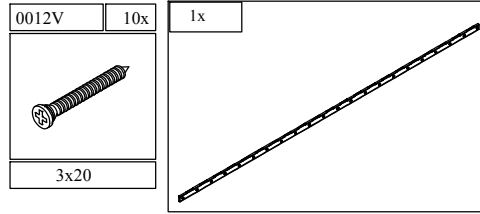
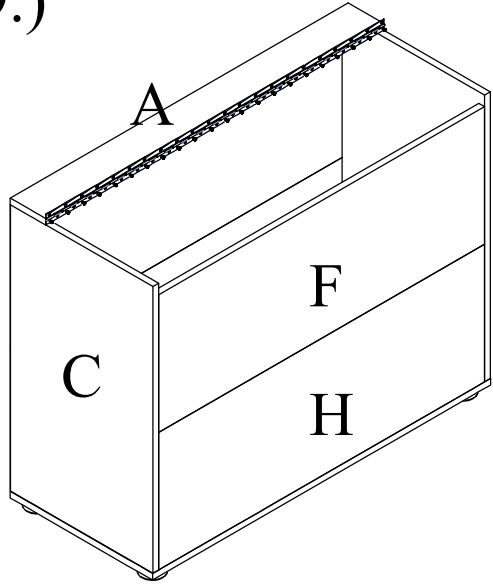

10.)

